

Slim Mech

Single Lift Up Door System



samet



*Simply Perfect
Completely Nature*

Introducing the latest addition to the SAMET Lift-Up Door product family, Slim Mech is meticulously designed to perform the ultimate customer experience in all living areas. With its ergonomic design providing maximum usable space and an advanced mechanical system, it showcases top-tier performance.



Aesthetic Design that Blends with Living Spaces

Slim Mech, with its well-thought-out minimalist design, adds elegance and aesthetics to your cabinets. The superior-quality nickel coating not only enhances its stylish appearance but also ensures years of use, even in the most challenging conditions.

Superior Performance with Sturdy Material Structure

Designed for long-life and top performance, Slim Mech boasts a robust material structure and state-of-the-art manufacturing technology. Its powerful mechanical system is produced with superior engineering.

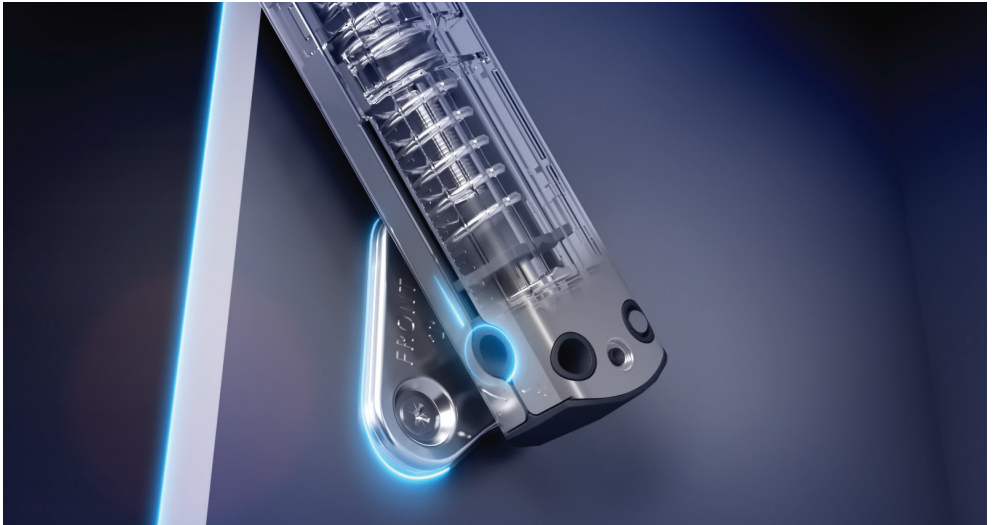

User-Friendly Silent and Soft-Closing

Slim Mech mechanisms, combined with LGA-certified Master Hinge Systems, ensure quiet operation and soft-closing for the lift up doors.

Easy-to-Use in All Living Areas

With four different spring force options, Slim Mech adapts to various living spaces and cabinets of different sizes. The power adjustment feature allows it to exhibit the best performance and ensuring ease of use in different applications.





Features

- Soft Close and Gradually Opening
- 3D Door Adjustment and Power Adjustment
- Super-Easy User Friendly Assembly
- 4 Different Power Units as A1,B1,C1,D1
- Cabinet Height Between 250 –600 mm
- Cabinet Width up to 1.200 mm

Package Included

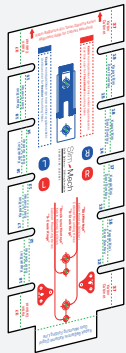

Drilling Template

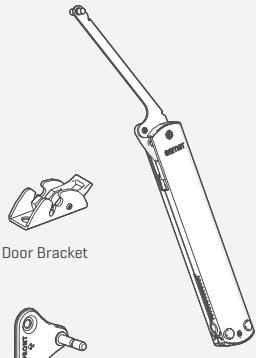

Door Bracket



Cabinet Bracket

Power Mechanism

Recommended Products

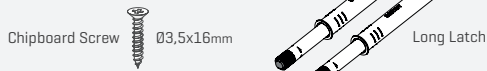

Chipboard Screw

Ø3,5x16mm

Long Latch



Master Mounting Plate [All Types]

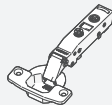

Master Soft-Close Hinge

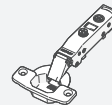

Master Self-Close Hinge

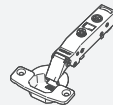

Master Free-Swing Hinge

Slim Mech | TECHNICAL DIMENSIONS

Full Overlay ["0 mm" Crank]

Mounting Plate Height	5 mm	7 mm	9 mm
Hd	164	166	168
Xd	37		
Kd	132		
Sd	18+B		

Half Overlay ["9 mm" Crank]

Mounting Plate Height	5 mm	7 mm	9 mm
Hy	173	175	177
Xy	37		
Ky	132		
Sy	18+B		

Inset ["18 mm" Crank]

Mounting Plate Height	5 mm	7 mm	9 mm
Hs	182	184	186
Xs	37+K		
Ks	132-P		
Ss	18-B		

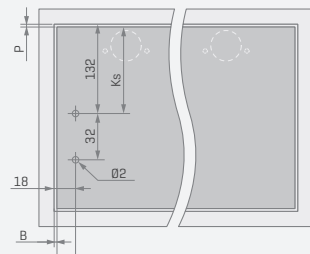
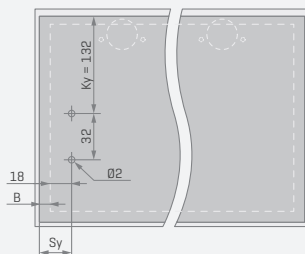
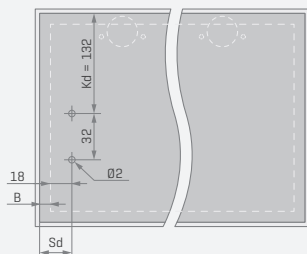
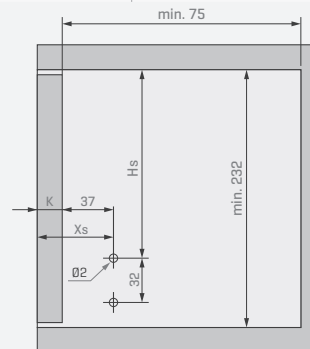
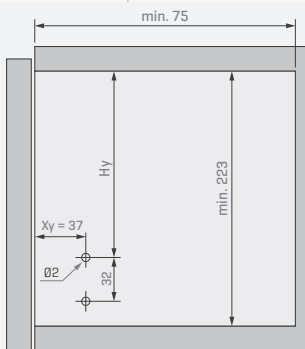
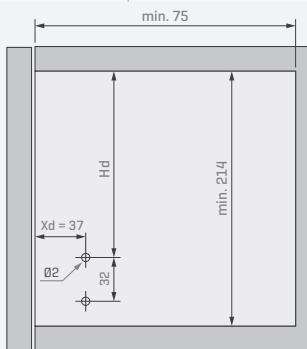

Slim Mech | CABINET DRILLING TEMPLATE

1 Fold the cabinet fold lines on the left to use the mechanism on the left cabinet side, and fold the cabinet fold lines on the right to use the mechanism on the right cabinet side, as shown.

2 Lean the alignment edge for cabinet.

3 Depending on the hinge type mark the required two holes and drill with Ø2mm drill bit.

Drilling template is convenient for "0 - Crank Hinge" and "9 - Crank Hinge" applications using "5 mm Mounting Plate."

"0-Crank Hinge" Cabinet Mounting Holes

"9-Crank Hinge" Cabinet Mounting Holes

Slim Mech | DOOR DRILLING TEMPLATE

1 Fold the "Door Mounting folding line" as shown.

2 Fold the "Door Overlay folding line" as shown according appropriate overlay dimension.

3 Align the folded areas to the door edges as shown.

4 Mark the required two holes and drill with Ø2mm drill bit.

Fold the left 'Door overlay' folding lines to use on the left door side, and fold the right 'Door overlay' folding lines to use on the right door side, and align on the door edge as shown.

Slim Mech | ASSEMBLY INSTRUCTIONS

1

2

3

Mounting Hole for Soft-Close

Mounting Hole for Push-Open

4

5

Click

Click

Ø10 min. 90

For the Push-Open door application, mount the "Long Latch" part at the specified location as shown.

POWER ADJUSTMENT

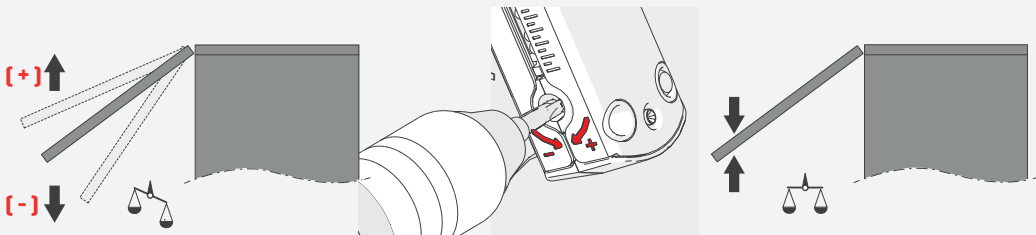

If the door in the open position is lifted and not fixed, turn in direction **(-)** and if it goes down, then turn in the direction **(+)** to adjust the balance.

DOOR ADJUSTMENT

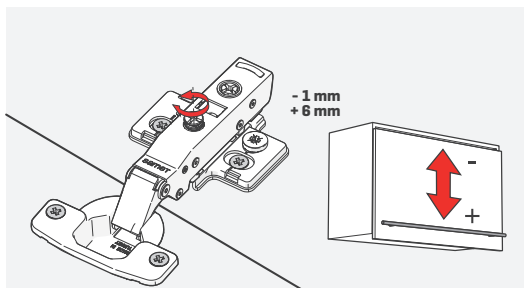
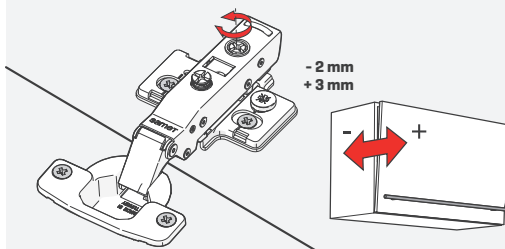
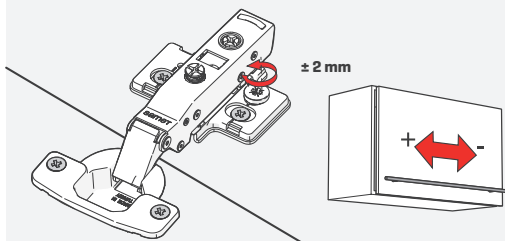

CAUTION

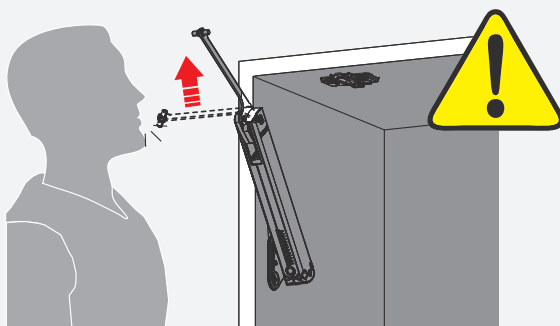

SLIM MECH SOFT-CLOSE	[Master Soft-Close x1] + [Master Self-Close x1]				Master Soft-Close x2			
	A		B		C		D	
Door Height	min kg	max kg	min kg	max kg	min kg	max kg	min kg	max kg
250-260	1	1,81	1,81	3,08	3,08	5,2	5,2	6,92
261-270	0,97	1,76	1,76	2,97	2,97	5	5	6,67
271-280	0,93	1,67	1,67	2,79	2,79	4,82	4,82	6,43
281-290	0,89	1,59	1,59	2,69	2,69	4,63	4,63	6,21
291-300	0,86	1,5	1,5	2,6	2,6	4,46	4,46	6
301-310	0,84	1,46	1,46	2,52	2,52	4,32	4,32	5,81
311-320	0,81	1,43	1,43	2,44	2,44	4,19	4,19	5,63
321-330	0,78	1,4	1,4	2,37	2,37	4,05	4,05	5,46
331-340	0,76	1,37	1,37	2,3	2,3	3,92	3,92	5,3
341-350	0,74	1,33	1,33	2,21	2,21	3,8	3,8	5,14
351-360	0,72	1,28	1,28	2,15	2,15	3,67	3,67	5
361-370	0,7	1,23	1,23	2,09	2,09	3,54	3,54	4,87
371-380	0,68	1,2	1,2	2,03	2,03	3,42	3,42	4,74
381-390	0,66	1,17	1,17	1,98	1,98	3,33	3,33	4,62
391-400	0,64	1,15	1,15	1,93	1,93	3,25	3,25	4,5
401-410	0,63	1,11	1,11	1,88	1,88	3,12	3,12	4,39
411-420	0,61	1,08	1,08	1,84	1,84	3,05	3,05	4,29
421-430	0,6	1,05	1,05	1,79	1,79	2,97	2,97	4,19
431-440	0,58	1,03	1,03	1,75	1,75	2,9	2,9	4,09
441-450	0,57	1	1	1,71	1,71	2,83	2,83	4
451-460	0,56	0,99	0,99	1,67	1,67	2,76	2,76	3,91
461-470	0,54	0,97	0,97	1,64	1,64	2,71	2,71	3,83
471-480	0,53	0,95	0,95	1,6	1,6	2,65	2,65	3,75
481-490	0,52	0,93	0,93	1,57	1,57	2,59	2,59	3,67
491-500	0,51	0,92	0,92	1,52	1,52	2,54	2,54	3,6
501-510	0,5	0,89	0,89	1,49	1,49	2,49	2,49	3,53
511-520	0,49	0,87	0,87	1,46	1,46	2,44	2,44	3,46
521-530	0,48	0,84	0,84	1,42	1,42	2,4	2,4	3,4
531-540	0,47	0,83	0,83	1,39	1,39	2,35	2,35	3,33
541-550	0,46	0,81	0,81	1,37	1,37	2,31	2,31	3,27
551-560	0,46	0,8	0,8	1,34	1,34	2,26	2,26	3,22
561-570	0,45	0,79	0,79	1,32	1,32	2,22	2,22	3,16
571-580	0,44	0,77	0,77	1,3	1,3	2,17	2,17	3,1
581-590	0,43	0,76	0,76	1,27	1,27	2,14	2,14	3,05
591-600	0,43	0,75	0,75	1,25	1,25	2,09	2,09	3

Less powerful mechanism is recommended for intersection areas.

If using the double-sided mechanism, the weight capacity is doubled.

*The door weights above includes door and handle together.

SLIM MECH PUSH-OPEN	[Master Self-Close x1] + [Master Free-Swing x1]								Push-Open Type
	A		B		C		D		
Door Height	min kg	max kg	min kg	max kg	min kg	max kg	min kg	max kg	
250-260	0,8	1,74	1,74	2,84	2,84	4,79	4,79	6,92	Yellow Push Open With Bumber (Code:10299964)
261-270	0,77	1,67	1,67	2,74	2,74	4,61	4,61	6,67	
271-280	0,74	1,59	1,59	2,62	2,62	4,41	4,41	6,43	
281-290	0,71	1,53	1,53	2,5	2,5	4,25	4,25	6,2	
291-300	0,69	1,47	1,47	2,4	2,4	4,1	4,1	6	
301-310	0,67	1,42	1,42	2,32	2,32	3,96	3,96	5,8	
311-320	0,65	1,38	1,38	2,25	2,25	3,83	3,83	5,62	
321-330	0,63	1,34	1,34	2,18	2,18	3,68	3,68	5,45	
331-340	0,6	1,3	1,3	2,12	2,12	3,55	3,55	5,29	
341-350	0,59	1,26	1,26	2,06	2,06	3,43	3,43	5,14	
351-360	0,57	1,21	1,21	1,99	1,99	3,33	3,33	5	
361-370	0,55	1,17	1,17	1,92	1,92	3,24	3,24	4,86	
371-380	0,54	1,13	1,13	1,86	1,86	3,12	3,12	4,73	
381-390	0,53	1,1	1,1	1,81	1,81	3,03	3,03	4,61	
391-400	0,51	1,08	1,08	1,76	1,76	2,94	2,94	4,5	
401-410	0,5	1,05	1,05	1,72	1,72	2,87	2,87	4,39	
411-420	0,49	1,03	1,03	1,68	1,68	2,8	2,8	4,29	
421-430	0,48	1	1	1,64	1,64	2,73	2,73	4,19	
431-440	0,46	0,98	0,98	1,6	1,6	2,67	2,67	4,09	
441-450	0,45	0,96	0,96	1,57	1,57	2,61	2,61	4	
451-460	0,44	0,94	0,94	1,53	1,53	2,55	2,55	3,91	
461-470	0,43	0,92	0,92	1,5	1,5	2,5	2,5	3,83	
471-480	0,42	0,9	0,9	1,47	1,47	2,44	2,44	3,75	
481-490	0,42	0,88	0,88	1,44	1,44	2,39	2,39	3,67	
491-500	0,41	0,86	0,86	1,41	1,41	2,35	2,35	3,6	
501-510	0,4	0,84	0,84	1,38	1,38	2,28	2,28	3,53	
511-520	0,39	0,83	0,83	1,35	1,35	2,22	2,22	3,46	
521-530	0,38	0,81	0,81	1,32	1,32	2,17	2,17	3,4	
531-540	0,38	0,8	0,8	1,3	1,3	2,13	2,13	3,33	
541-550	0,37	0,78	0,78	1,27	1,27	2,09	2,09	3,27	
551-560	0,36	0,77	0,77	1,25	1,25	2,05	2,05	3,21	
561-570	0,36	0,76	0,76	1,23	1,23	2,01	2,01	3,16	
571-580	0,35	0,74	0,74	1,21	1,21	1,98	1,98	3,1	
581-590	0,34	0,73	0,73	1,19	1,19	1,95	1,95	3,05	
591-600	0,34	0,72	0,72	1,17	1,17	1,92	1,92	3	

Less powerful mechanism is recommended for intersection areas.

If using the double-sided mechanism, the weight capacity is doubled.

Code	Description	Power	Package	Quantity [pc]
12427640008001	SLIM MECH Retail	A1	Retail	1
12427740008001	SLIM MECH Retail	B1	Retail	1
12427840008001	SLIM MECH Retail	C1	Retail	1
12427440008001	SLIM MECH Retail	D1	Retail	1
12427630008001	SLIM MECH Retail	A1	Retail	2
12427730008001	SLIM MECH Retail	B1	Retail	2
12427830008001	SLIM MECH Retail	C1	Retail	2
12427430008001	SLIM MECH Retail	D1	Retail	2





Code	Description	Power	Package	Quantity [pc]
12427620008001	SLIM MECH Wholesale	A1	Wholesale	40
12427720008001	SLIM MECH Wholesale	B1	Wholesale	40
12427820008001	SLIM MECH Wholesale	C1	Wholesale	40
12427420008001	SLIM MECH Wholesale	D1	Wholesale	40

Code	Description	Power	Package	Quantity [pc]
12427650008001	SLIM MECH Bulk	A1	Bulk	468
12427750008001	SLIM MECH Bulk	B1	Bulk	468
12427850008001	SLIM MECH Bulk	C1	Bulk	468
12427450008001	SLIM MECH Bulk	D1	Bulk	468

samet



sametglobal.com

-  SametGroup
-  SametGroup
-  Samet Kalıp ve Madeni Eşya San. ve Tic. A.Ş.
-  sametinternational